

Construction

- Current-compensated ring core double choke with ferrite core
- Polycarbonate case
- Polyurethane potting
- Sector winding



Features

- Case and potting flame-retardant as per UL 94 V-0
- High resonance frequency owing to special winding technique
- Approx. 1 % stray inductance for symmetrical interference suppression



Applications

Application	Type
Electronic ballasts in lamps	B82721
	B82722
Switch-mode power supplies in TV sets	B82721 ...
	B82725
Washing machines	B82724
	B82725
Power supplies	B82724
	B82725
Chargers	B82725



Terminals

- Pins 0,7 × 0,7 mm or 1 × 1 mm (B82725)
- Pins fitting standard PCB grid

Marking

Ordering code, rated current, rated inductance, rated voltage (except B82721-K), graphic symbol, mark of conformity, manufacturer, date of manufacture

Approvals¹⁾

Marks of conformity	Standards
	VDE 0565-2
	EN 60938-2 (pending)
	UL 1283

1) Approvals to EN 60938-2 and UL 1283 pending for B82725-J.

Dimensional drawings and pin configuration

Horizontal version (B82721-A)

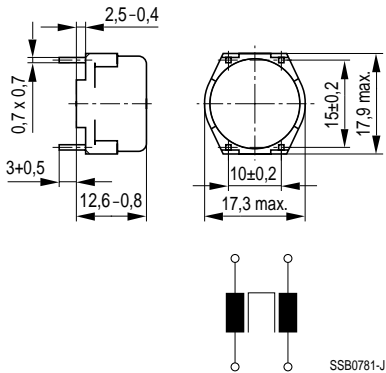

Vertical version (B82721-K)

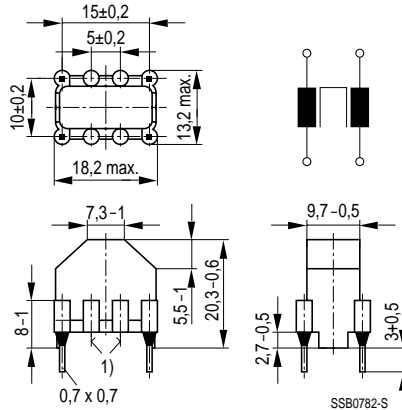
General technical data

Rated voltage V_R	250 Vac
Test voltage V_T	1500 Vac, 2 s (line/line)
Rated current I_R	Referred to 50 Hz and 40 °C ambient temperature
Inductance tolerance	± 30 %
Weight	Approx. 5 g

 For further technical data [see page 334](#). For impedance = f (f) [see page 355](#)
Characteristics and ordering codes

I_R A	L_R mH	L_S , typ μH	R_{typ} mΩ	Ordering code	
				horizontal version	vertical version
0,4	39	450	2000	B82721-A2401-N20	B82721-K2401-N20
0,4	27	270	1700	B82721-A2401-N21	B82721-K2401-N21
0,5	18	260	1500	B82721-A2501-N1	B82721-K2501-N1
0,7	10	90	600	B82721-A2701-N20	B82721-K2701-N20
1,2	6,8	70	280	B82721-A2122-N20	B82721-K2122-N20
1,5	3,3	37	190	B82721-A2152-N1	B82721-K2152-N1
2,0	1,0	13	90	B82721-A2202-N1	B82721-K2202-N1
2,6	0,4	6	60	B82721-A2262-N1	B82721-K2262-N1
3,6	0,4	6	35	B82721-A2362-N1	B82721-K2362-N1

1) Vertical version with lead spacing 5 mm × 10 mm upon request.

Dimensional drawings and pin configuration

Horizontal version (B82722-A)

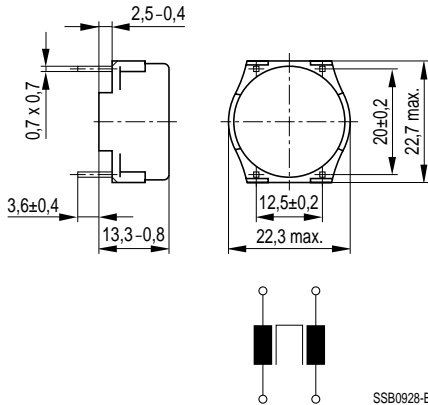

Vertical version (B82722-J)

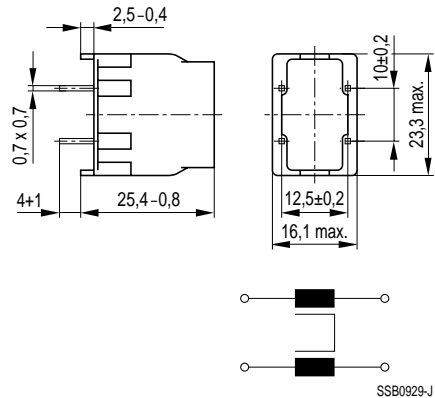
General technical data

Rated voltage V_R	250 Vac
Test voltage V_T	1500 Vac, 2 s (line/line)
Rated current I_R	Referred to 50 Hz and 60 °C ambient temperature
Inductance tolerance	± 30 %
Weight	Approx. 10 g

 For further technical data [see page 334](#). For impedance = f (f) [see page 355](#)
Characteristics and ordering codes

I_R A	L_R mH	L_S , typ μ H	R_{typ} m Ω	Ordering code	
				horizontal version	vertical version
0,3	47	760	2500	B82722-A2301-N1	B82722-J2301-N1
0,5	27	430	1200	B82722-A2501-N1	B82722-J2501-N1
1	10	140	480	B82722-A2102-N1	B82722-J2102-N1
2	2,2	30	130	B82722-A2202-N1	B82722-J2202-N1
3	1,2	17	56	B82722-A2302-N1	B82722-J2302-N1

Dimensional drawings and pin configuration

Horizontal version (B82723-A)

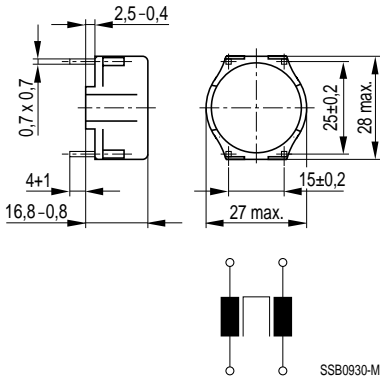

Vertical version (B82723-J)

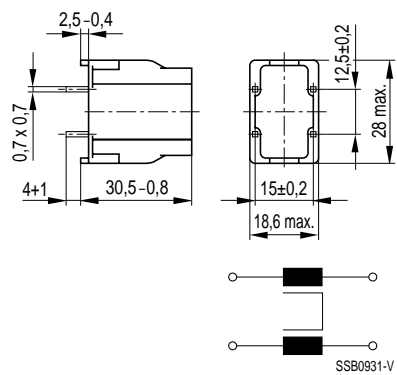
General technical data

Rated voltage V_R	250 Vac
Test voltage V_T	1500 Vac, 2 s (line/line)
Rated current I_R	Referred to 50 Hz and 60 °C ambient temperature
Inductance tolerance	± 30 %
Weight	Approx. 20 g

 For further technical data [see page 334](#). For impedance = f (f) [see page 355](#)
Characteristics and ordering codes

I_R A	L_R mH	L_S , typ μH	R_{typ} mΩ	Ordering code	
				horizontal version	vertical version
0,5	56	870	2200	B82723-A2501-N1	B82723-J2501-N1
1	27	440	750	B82723-A2102-N1	B82723-J2102-N1
2	5,6	80	160	B82723-A2202-N1	B82723-J2202-N1
4	2,7	30	60	B82723-A2402-N1	B82723-J2402-N1

Dimensional drawings and pin configuration

Horizontal version (B82724-A)

Vertical version (B82724-J)

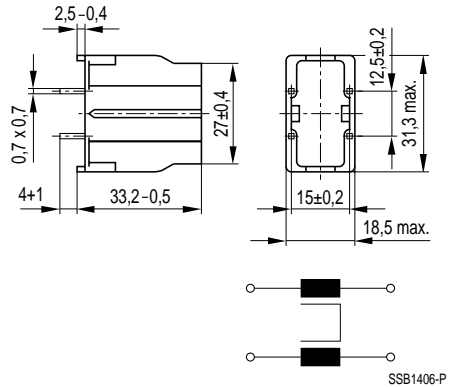
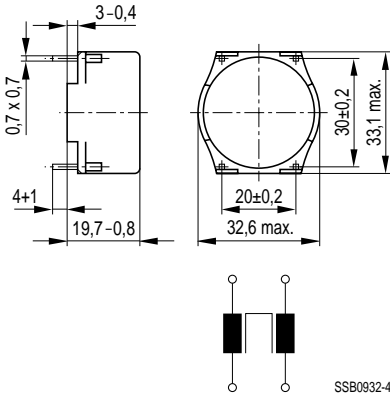
General technical data

Rated voltage V_R	250 Vac
Test voltage V_T	1500 Vac, 2 s (line/line)
Rated current I_R	Referred to 50 Hz and 60 °C ambient temperature
Inductance tolerance	± 30 %
Weight	Approx. 25 g

 For further technical data [see page 334](#). For impedance = f (f) [see page 356](#)
Characteristics and ordering codes

I_R A	L_R mH	L_S , typ μ H	R_{typ} m Ω	Ordering code	
				horizontal version	vertical version
0,5	82	1000	2700	B82724-A2501-N1	B82724-J2501-N1
1	33	420	810	B82724-A2102-N1	B82724-J2102-N1
1,4	27	310	500	B82724-A2142-N1	B82724-J2142-N1
2	6,8	80	190	B82724-A2202-N1	B82724-J2202-N1
4	3,3	40	66	B82724-A2402-N1	B82724-J2402-N1

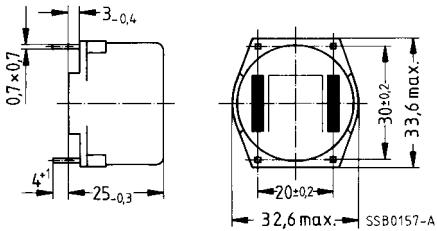
Dimensional drawings and pin configuration

General technical data

Rated voltage V_R	250 Vac
Test voltage V_T	1500 Vac, 2 s (line/line)
Rated current I_R	Referred to 50 Hz and 60 °C ambient temperature
Inductance tolerance	$\pm 30 \%$
Weight	Approx. 40 g

For further technical data [see page 334](#). For impedance = f (f) [see page 356](#)

Characteristics and ordering codes

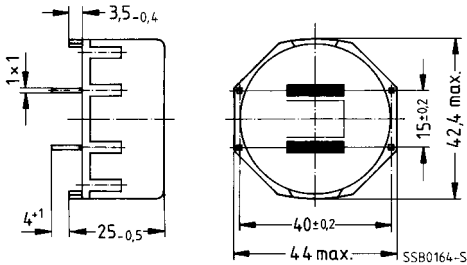
I_R A	L_R mH	L_S , typ μ H	R_{typ} m Ω	Ordering code
1	47	550	880	B82724-B2102-N1
2	10	110	230	B82724-B2202-N1
4	3,9	40	58	B82724-B2402-N1
6	1,8	16	23	B82724-B2602-N1

Dimensional drawings and pin configuration

General technical data

Rated voltage V_R	250 Vac
Test voltage V_T	1500 Vac, 2 s (line/line)
Rated current I_R	Referred to 50 Hz and 60 °C ambient temperature
Inductance tolerance	± 30 %
Weight	Approx. 60 g

For further technical data [see page 334](#). For impedance = f (f) [see page 356](#)

Characteristics and ordering codes

I_R A	L_R mH	L_S , typ μ H	R_{typ} m Ω	Ordering code ¹⁾
1	68	900	1300	B82725-A2102-N1
2	18	230	350	B82725-A2202-N1
4	6,8	80	87	B82725-A2402-N1
6	3,9	45	41	B82725-A2602-N1
8	2,7	30	22	B82725-A2802-N1
10	1,8	20	14	B82725-A2103-N1

1) Chokes with 8 pins upon request.

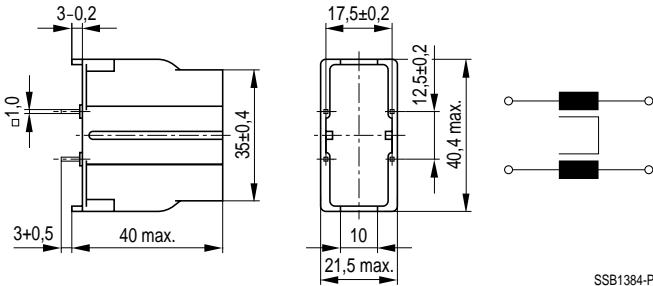
Dimensional drawings and pin configuration

SSB1384-P

General technical data

Rated voltage V_R	250 Vac
Test voltage V_T	1500 Vac, 2 s (line/line)
Rated current I_R	Referred to 50 Hz and 60 °C ambient temperature
Inductance tolerance	± 30 %
Weight	Approx. 50 g

 For further technical data [see page 334](#). For impedance = f (f) [see page 356](#)
Characteristics and ordering codes

I_R A	L_R mH	L_S , typ μ H	R_{typ} m Ω	Ordering code
1	68	590	1050	B82725-J2102-N20
2	18	170	270	B82725-J2202-N20
4	6,8	60	77	B82725-J2402-N20
6	3,9	34	34	B82725-J2602-N20
8	2,7	26	20	B82725-J2802-N20
10	1,8	18	13	B82725-J2103-N22

Impedance $|Z|$ versus frequency f
(measured with windings in parallel)

B82721-*
* = A or K

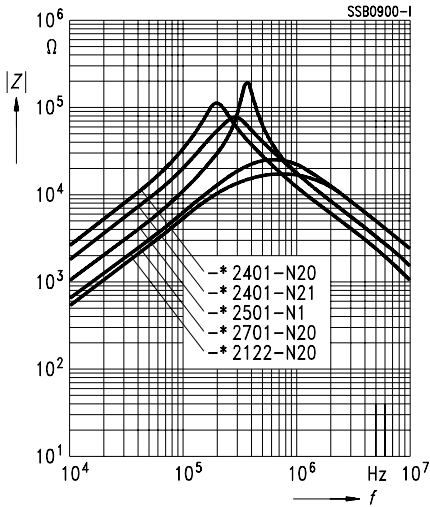

B82721-*
* = A or K

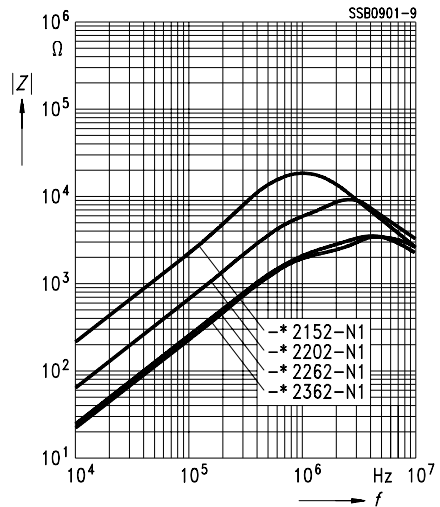

B82722-*
* = A or J

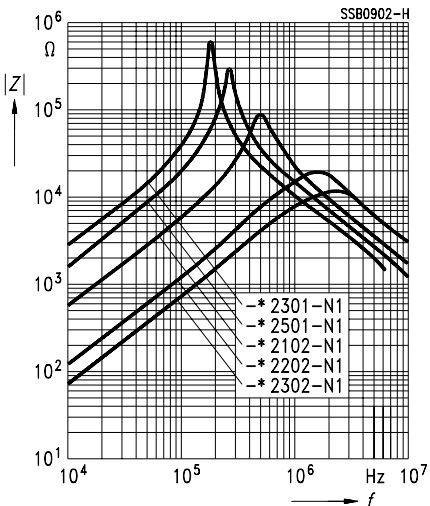

B82723-*
* = A or J

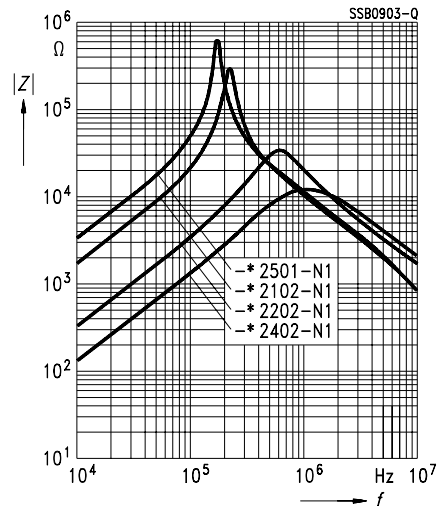

Impedance $|Z|$ versus frequency f
(measured with windings in parallel)

B82724-*

* = A or J

B82724-B

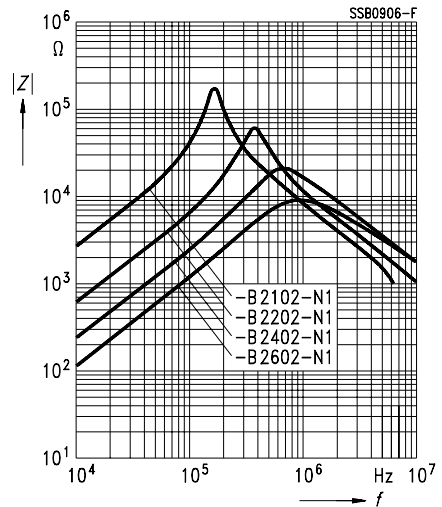
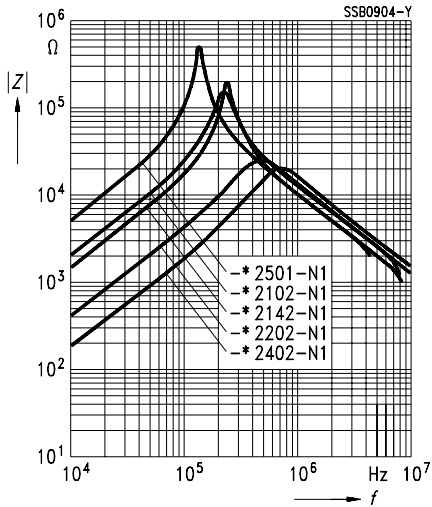

B82725-A

B82725-J

